

Haltegriffsystem Serie IneoLine Pure (Edelstahl)

Système de barres d'appui Série IneoLine Pure (acier inoxydable)

Sistema di maniglioni di sostegno Serie IneoLine Pure
(acciaio inossidabile)



Haltegriffsystem Serie IneoLine Pure (Edelstahl)

Système de barres d'appui Série IneoLine Pure (acier inoxydable)

Sistema di maniglioni di sostegno Serie IneoLine Pure (acciaio inossidabile)

Qualitätsmerkmale

Material

- Edelstahl 1.4301
- Rohrdurchmesser 32 mm
- Materialstärken 1.5 mm

Für die maximale Belastung unserer Artikel wenden Sie sich bitte an das NOSAG Team.

Masse

Alle Masse sind Achse – Achse gemessen (Ausnahme, die Duschhandläufe sind Achse – Wand gemessen)

- Wandabstand - Achse Rohr 64 mm

Unsere Masszeichnungen finden Sie unter www.nosag.ch/download

Für Spezialanfertigungen bitte die Vorlagen für Massangaben auf unserer Internetseite benutzen.

Montage

- Bohrschablonen auf Anfrage erhältlich
- Alle Produkte werden mit verdeckter Montage geliefert
- Bei den Haltegriffen wird das Montagmaterial mitgeliefert
- Für alle klappbaren Produkte und die Stützgriffe muss das Montagmaterial entsprechend des Mauerwerks bestellt werden

Alle abgebildeten Winkelgriffe und Duschhandläufe sind Ausführung links.

Ausführungen



Edelstahl, hochglanz poliert, DesignGrip by Nosag®
acier inoxydable, poli, DesignGrip by Nosag®

Signes de qualité

matériaux

- acier inoxydable 1.4301
- diamètre 32 mm
- épaisseur du matériau 1.5 mm

Pour la charge maximum veuillez s.v.p. demander au team NOSAG.

measures

toutes les dimensions s'entendent d'axe en axe des tubes (exception; les barre d'appui d'angle s'entendent axe – mur)

- distance du mur au tube 64 mm

vous trouvez nos plans sous www.nosag.ch/download

Pour toutes demandes de barre sur mesure, veuillez remplir le formulaire mis à disposition sur notre site internet.

montage

- chablon de perçement sur demande.
- tous les produits sont livrés avec montage invisible
- les barres d'appui sont livrées avec vis et tampons
- pour les produits rabattables et barre d'appui mural les fixation au mur sont à définir suivant la nature du support.

Toutes les images des barres d'appui d'angle sont des exécutions gauches.

exécution



Edelstahl, matt gebürstet, DesignGrip by Nosag®
acier inoxydable, mat, DesignGrip by Nosag®

Haltegriffsystem Serie IneoLine Pure (Edelstahl)

Système de barres d'appui Série IneoLine Pure (acier inoxydable)

Sistema di maniglioni di sostegno Serie IneoLine Pure
(acciaio inossidabile)

Caratteristiche qualitative

Materiale

| | |
|--------------------------|--------|
| • Acciaio inossidabile | 1.4301 |
| • Diametro tubolare | 32 mm |
| • Spessori del materiale | 1.5 mm |

Per il carico massimo dei nostri articoli vi preghiamo di rivolgervi al team NOSAG.

Misure

Tutte le misure sono calcolate da asse ad asse (eccezione, i maniglioni per doccia sono misurati da asse a parete)

| | |
|---|-------|
| • Distanza dalla parete - Asse del tubolare | 64 mm |
|---|-------|

I nostri disegni tecnici quotati sono disponibili sul sito www.nosag.ch/download

Per realizzazioni su ordinazione utilizzare i modelli per l'indicazione delle misure disponibili sul nostro sito Internet.

Montaggio

- Su richiesta sono disponibili dime per la foratura
- Tutti i prodotti vengono forniti con elementi di montaggio nascosti
- Per i maniglioni di sostegno il materiale per il montaggio è compreso nella dotazione
- per tutti i prodotti pieghevoli e le impugnature di supporto il materiale per il montaggio deve essere ordinato in base al tipo di muratura

Tutte le maniglie angolari e i maniglioni per doccia sono raffigurati nella versione sinistra.

Versioni



acciaio inossidabile, brillante, DesignGrip by Nosag®



acciaio inossidabile, opaco, DesignGrip by Nosag®

Haltegriffsystem Serie IneoLine Pure (Edelstahl)

Système de barres d'appui Série IneoLine Pure (acier inoxydable)

Sistema di maniglioni di sostegno Serie IneoLine Pure

(acciaio inossidabile)

WC-Bereich

Section toilette / Settore toilette



Haltegriff

Barre d'appui / Corrimano

Edelstahl, mit DesignGrip by Nosag®

Acier inoxydable, avec DesignGrip by Nosag® / Acciaio inossidabile, con DesignGrip by Nosag®

| NOSAG | SGVSB Team | Sanitas Troesch | A | B | C |
|----------------------------|------------|-----------------|------|---|---|
| PW0.0003.525 ^{a1} | 585 020 | 4721 901 | 300 | | |
| PW0.0004.525 ^{a1} | 585 021 | | 400 | | |
| PW0.0006.525 ^{a1} | 585 022 | 4721 903 | 600 | | |
| PW0.0008.525 ^{a1} | 585 023 | 4721 904 | 800 | | |
| PW0.0009.525 ^{a1} | 585 024 | | 900 | | |
| PW0.0010.525 ^{a1} | 585 025 | 4721 906 | 1000 | | |
| PW0.0011.525 ^{a1} | 585 026 | | 1100 | | |
| PW0.0003.583 ^{b1} | 585 020 | 4721 901 | 300 | | |
| PW0.0004.583 ^{b1} | 585 021 | | 400 | | |
| PW0.0006.583 ^{b1} | 585 022 | 4721 903 | 600 | | |
| PW0.0008.583 ^{b1} | 585 023 | 4721 904 | 800 | | |
| PW0.0009.583 ^{b1} | 585 024 | | 900 | | |
| PW0.0010.583 ^{b1} | 585 025 | 4721 906 | 1000 | | |
| PW0.0011.583 ^{b1} | 585 026 | | 1100 | | |

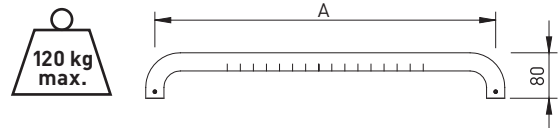

Haken

Chrochet / Gancio d'appoggio

Kunststoff, zum anklebmen, für Rohr d = 32 mm

Nylon, montage sur la barre d'appui d = 32 mm / Nylon, per corrimano d = 32 mm

| NOSAG | SGVSB Team | Sanitas Troesch | A | B | C |
|--|------------|-----------------|----|---|---|
| PDA.1730.501 | | | 73 | | |
| verchromt / chromé / cromato | | | | | |
| PDA.1730.337 | | | 73 | | |
| dunkelgrau / gris foncé / grigio scuro | | | | | |

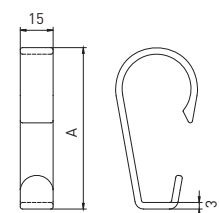

Haltegriffsystem Serie IneoLine Pure (Edelstahl)

Système de barres d'appui Série IneoLine Pure (acier inoxydable)

Sistema di maniglioni di sostegno Serie IneoLine Pure (acciaio inossidabile)

WC-Bereich

Section toilette / Settore toilette



Winkelgriff

Poignées de sécurité / Corrimano ad angolo

Edelstahl, mit DesignGrip by Nosag®

Acier inoxydable, avec DesignGrip by Nosag® / Acciaio inossidabile, con DesignGrip by Nosag®

| NOSAG | SGVSB Team | Sanitas Troesch | A | B | C |
|------------------------------|------------|-----------------|-----|-----|---|
| PW1.0044.525.L ^{a)} | 585 035 | 4721 915 | 415 | 415 | |
| PW1.0044.525.R ^{a)} | 585 036 | 4721 916 | 415 | 415 | |
| PW1.0044.583.L ^{b)} | 585 035 | 4721 915 | 415 | 415 | |
| PW1.0044.583.R ^{b)} | 585 036 | 4721 916 | 415 | 415 | |

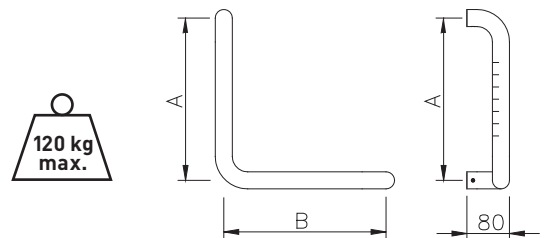

Winkelgriff

Poignées de sécurité / Corrimano ad angolo

Edelstahl, mit DesignGrip by Nosag®

Acier inoxydable, avec DesignGrip by Nosag® / Acciaio inossidabile, con DesignGrip by Nosag®

| NOSAG | SGVSB Team | Sanitas Troesch | A | B | C |
|------------------------------|------------|-----------------|-----|-----|---|
| PW1.0036.525.L ^{a)} | 585 029 | | 610 | 305 | |
| PW1.0036.525.R ^{a)} | 585 030 | | 610 | 305 | |
| PW1.0036.583.L ^{b)} | 585 029 | | 610 | 305 | |
| PW1.0036.583.R ^{b)} | 585 030 | | 610 | 305 | |

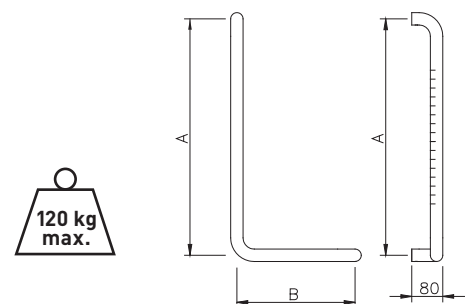

Haltegriffsystem Serie IneoLine Pure (Edelstahl)

Système de barres d'appui Série IneoLine Pure (acier inoxydable)

Sistema di maniglioni di sostegno Serie IneoLine Pure (acciaio inossidabile)

WC-Bereich

Section toilette / Settore toilette

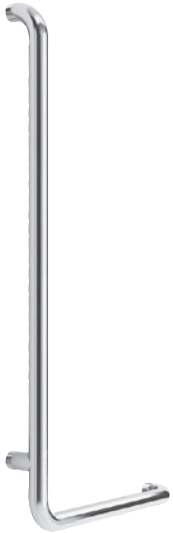

Winkelgriff

Poignées de sécurité / Corrimano ad angolo

Edelstahl, mit DesignGrip by Nosag®

Acier inoxydable, avec DesignGrip by Nosag® / Acciaio inossidabile, con DesignGrip by Nosag®

| NOSAG | SGVSB Team | Sanitas Troesch | A | B | C |
|------------------------------|------------|-----------------|-----|-----|---|
| PW1.0059.525.L ^{a)} | 585 031 | 4721 919 | 950 | 500 | |
| PW1.0059.525.R ^{a)} | 585 032 | 4721 920 | 950 | 500 | |
| PW1.0048.525.L ^{a)} | 585 033 | 4721 921 | 815 | 405 | |
| PW1.0048.525.R ^{a)} | 585 034 | 4721 922 | 815 | 405 | |
| PW1.0059.583.L ^{b)} | 585 031 | 4721 919 | 950 | 500 | |
| PW1.0059.583.R ^{b)} | 585 032 | 4721 920 | 950 | 500 | |
| PW1.0048.583.L ^{b)} | 585 033 | 4721 921 | 815 | 405 | |
| PW1.0048.583.R ^{b)} | 585 034 | 4721 922 | 815 | 405 | |

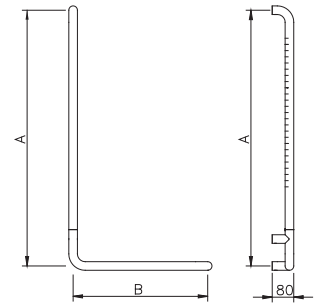

Haltegriffsystem Serie IneoLine Pure (Edelstahl)

Système de barres d'appui Série IneoLine Pure (acier inoxydable)

Sistema di maniglioni di sostegno Serie IneoLine Pure
(acciaio inossidabile)

WC-Bereich

Section toilette / Settore toilette



Stützklappgriff

Barre d'appui rabattable / Corrimano ribaltabile

Edelstahl, mit DesignGrip by Nosag® mit Fallsicherung, **MIT Wechselplatte**

Acier inoxydable, avec DesignGrip by Nosag®, avec frein de sécurité, **AVEC plaque interchangeable /**
Acciaio inossidabile, con DesignGrip by Nosag®, con freno di sicurezza, **CON placca intercambiabile**

| NOSAG | SGVSB Team | Sanitas Troesch | A | B | C |
|----------------------------|------------|-----------------|-----|-----|-----|
| LW2.0006.525 ^{a)} | 585 317 | 4721 884 | 600 | 250 | 110 |
| LW2.0007.525 ^{a)} | 585 318 | 4721 885 | 720 | 250 | 110 |
| LW2.0008.525 ^{a)} | 585 319 | 4721 886 | 850 | 250 | 110 |
| LW2.0006.583 ^{b)} | 585 317 | 4721 884 | 600 | 250 | 110 |
| LW2.0007.583 ^{b)} | 585 318 | 4721 885 | 720 | 250 | 110 |
| LW2.0008.583 ^{b)} | 585 319 | 4721 886 | 850 | 250 | 110 |

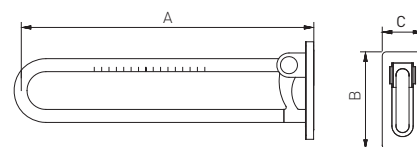

Montageset für

Set de montage pour / Set montaggio per

| | NOSAG | SGVSB Team | Sanitas Troesch |
|---|--------------|------------|-----------------|
| Lochziegelsteine Brique / Mattone forato | LM1.0100.000 | 585 390 | 4721 387 |
| Vorwandssysteme Murs préfabriqués / Muri prefabbricati | LM1.0200.000 | 585 391 | 4721 388 |
| Beton Béton / Calcestruzzo | LM1.0300.000 | 585 392 | |
| Vollgipsplatten Plaque alba / Lastre gesso | LM1.0500.000 | 585 394 | |

Haltegriffsystem Serie IneoLine Pure (Edelstahl)

Système de barres d'appui Série IneoLine Pure (acier inoxydable)

Sistema di maniglioni di sostegno Serie IneoLine Pure
(acciaio inossidabile)

WC-Bereich

Section toilette / Settore toilette



Stützklappgriff

Barre d'appui rabattable / Corrimano ribaltabile

Edelstahl, mit DesignGrip by Nosag® mit Fallsicherung, **FÜR Wechselplatte**

Acier inoxydable, avec DesignGrip by Nosag®, avec frein de sécurité, **POUR plaque de base /**

Acciaio inossidabile, con DesignGrip by Nosag®, con freno di sicurezza, **PER placca di base**

| NOSAG | SGVSB Team | Sanitas Troesch | A | B | C |
|----------------------------|------------|-----------------|-----|-----|-----|
| LW2.0086.525 ^{a)} | | | 600 | 250 | 110 |
| LW2.0087.525 ^{a)} | | | 720 | 250 | 110 |
| LW2.0088.525 ^{a)} | | | 850 | 250 | 110 |
| LW2.0086.583 ^{b)} | | | 600 | 250 | 110 |
| LW2.0087.583 ^{b)} | | | 720 | 250 | 110 |
| LW2.0088.583 ^{b)} | | | 850 | 250 | 110 |

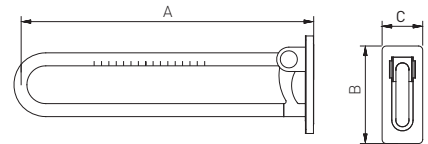

Haltegriffsystem Serie IneoLine Pure (Edelstahl)

Système de barres d'appui Série IneoLine Pure (acier inoxydable)

Sistema di maniglioni di sostegno Serie IneoLine Pure (acciaio inossidabile)

WC-Bereich

Section toilette / Settore toilette



Stützklappgriff

Barre d'appui rabattable / Corrimano ribaltabile

Edelstahl, mit Papierhalter, mit DesignGrip by Nosag®, mit Fallsicherung, **MIT Wechselplatte**

Acier inoxydable, avec porte-rouleau, avec DesignGrip by Nosag®, avec frein de sécurité, **AVEC plaque de base** / Acciaio inossidabile, con portacarta, con DesignGrip by Nosag®, con freno di sicurezza, **CON placca di base**

| NOSAG | SGVSB Team | Sanitas Troesch | A | B | C |
|----------------------------|------------|-----------------|-----|-----|-----|
| LW2.0036.525 ^{al} | 585 320 | 4721 881 | 600 | 250 | 110 |
| LW2.0037.525 ^{al} | 585 321 | 4721 882 | 720 | 250 | 110 |
| LW2.0038.525 ^{al} | 585 322 | 4721 883 | 850 | 250 | 110 |
| LW2.0036.583 ^{bl} | 585 320 | 4721 881 | 600 | 250 | 110 |
| LW2.0037.583 ^{bl} | 585 321 | 4721 882 | 720 | 250 | 110 |
| LW2.0038.583 ^{bl} | 585 322 | 4721 883 | 850 | 250 | 110 |

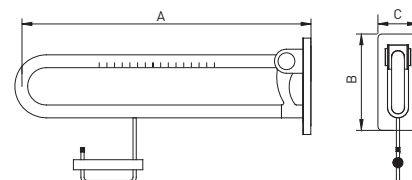

Montageset für

Set de montage pour / Set montaggio per

| | NOSAG | SGVSB Team | Sanitas Troesch |
|---|--------------|------------|-----------------|
| Lochziegelsteine Brique / Mattone forato | LM1.0100.000 | 585 390 | 4721 387 |
| Vorwandssysteme Murs préfabriqués / Muri prefabbricati | LM1.0200.000 | 585 391 | 4721 388 |
| Beton Béton / Calcestruzzo | LM1.0300.000 | 585 392 | |
| Vollgipsplatten Plaque alba / Lastre gesso | LM1.0500.000 | 585 394 | |

Haltegriffsystem Serie IneoLine Pure (Edelstahl)

Système de barres d'appui Série IneoLine Pure (acier inoxydable)

Sistema di maniglioni di sostegno Serie IneoLine Pure

(acciaio inossidabile)

WC-Bereich

Section toilette / Settore toilette



Stützklappgriff

Barre d'appui rabattable / Corrimano ribaltabile

Edelstahl, mit Papierhalter, mit DesignGrip by Nosag®, mit Fallsicherung, **FÜR Wechselplatte**

Acier inoxydable, avec porte-rouleau, avec DesignGrip by Nosag®, avec frein de sécurité, **POUR plaque interchangeable** / Acciaio inossidabile, con portacarta, con DesignGrip by Nosag®, con freno di sicurezza, **PER placca intercambiabile**

| NOSAG | SGVSB Team | Sanitas Troesch | A | B | C |
|----------------------------|------------|-----------------|-----|-----|-----|
| LW2.0076.525 ^{a1} | | | 600 | 250 | 110 |
| LW2.0077.525 ^{a1} | | | 720 | 250 | 110 |
| LW2.0078.525 ^{a1} | | | 850 | 250 | 110 |
| LW2.0076.583 ^{b1} | | | 600 | 250 | 110 |
| LW2.0077.583 ^{b1} | | | 720 | 250 | 110 |
| LW2.0078.583 ^{b1} | | | 850 | 250 | 110 |

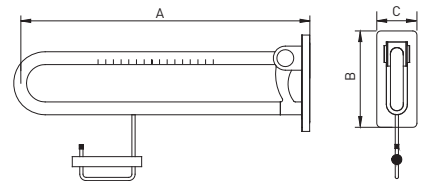

Montageplatte mit Abdeckung

Plaque de base / Placca di base con copertura

Edelstahl

Acier inoxydable / Acciaio inossidabile

| NOSAG | SGVSB Team | Sanitas Troesch | A | B | C |
|----------------------------|------------|-----------------|-----|-----|----|
| LWA.0033.525 ^{a1} | 585 380 | | 239 | 106 | 17 |
| LWA.0033.583 ^{b1} | 585 380 | | 239 | 106 | 17 |

Montageset für

Set de montage pour / Set montaggio per

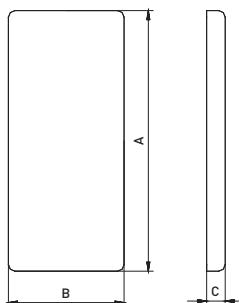

| | NOSAG | SGVSB Team | Sanitas Troesch |
|---|--------------|------------|-----------------|
| Lochziegelsteine Brique / Mattone forato | LM1.0100.000 | 585 390 | 4721 387 |
| Vorwandssysteme Murs préfabriqués / Muri prefabbricati | LM1.0200.000 | 585 391 | 4721 388 |
| Beton Béton / Calcestruzzo | LM1.0300.000 | 585 392 | |
| Vollgipsplatten Plaque alba / Lastre gesso | LM1.0500.000 | 585 394 | |

a) = hochglanz poliert, poli, brillante / b) = matt gebürstet, mat, opaco

* Farbskala siehe Seite 254 / gamme de couleurs voir la page 254 / gamma di colori vedere pagina 254

Haltegriffsystem Serie IneoLine Pure (Edelstahl)

Système de barres d'appui Série IneoLine Pure (acier inoxydable)

Sistema di maniglioni di sostegno Serie IneoLine Pure
(acciaio inossidabile)

WC-Bereich

Section toilette / Settore toilette



Papierrollenhalter

Porte-rouleau / Portacarta

Edelstahl, mit Blattstopper

Acier inoxydable, avec couvercle / Acciaio inossidabile, con freno srotolamento

| NOSAG | SGVSB Team | Sanitas Troesch | A | B | C |
|----------------------------|------------|-----------------|---|---|---|
| PWA.1111.525 ^{a)} | 585 332 | 4721 961 | | | |
| PWA.1111.583 ^{b)} | 585 332 | 4721 961 | | | |

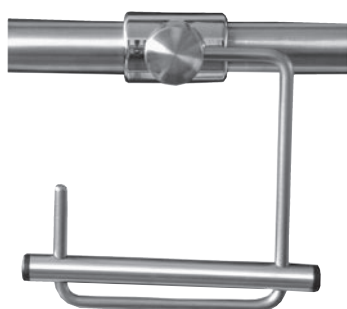

Papierrollenhalter

Porte-rouleau / Portacarta

Edelstahl, zum Anklemmen

Acier inoxydable, pour montage à la barre / Acciaio inossidabile, moletta di fissaggio

| NOSAG | SGVSB Team | Sanitas Troesch | A | B | C |
|----------------------------|------------|-----------------|---|---|---|
| PWA.1102.525 ^{a)} | 585 333 | | | | |
| PWA.1102.583 ^{b)} | 585 333 | | | | |



Rückenstütze

Dossier / Schienale

Edelstahl, mit Rückenkissen, schwarz

Acier inoxydable, rembourrage noir / Acciaio inossidabile, schienale imbottito, nero

| NOSAG | SGVSB Team | Sanitas Troesch | A | B | C |
|----------------------------|------------|-----------------|-----|-----|-----|
| PWA.1410.525 ^{a)} | 585 415 | 4721 399 | 530 | 400 | 200 |
| PWA.1410.583 ^{b)} | 585 415 | 4721 399 | 530 | 400 | 200 |

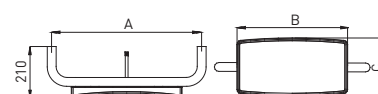

Haltegriffsystem Serie IneoLine Pure (Edelstahl)

Système de barres d'appui Série IneoLine Pure (acier inoxydable)

Sistema di maniglioni di sostegno Serie IneoLine Pure (acciaio inossidabile)

WC-Bereich

Section toilette / Settore toilette



Ersatzrollenhalter

Porte-rouleau de réserve / Portacarta di riserva

Edelstahl, für 1 Rolle

Acier inoxydable, pour 1 rouleau / Acciaio inossidabile, per 1 rotolo

| NOSAG | SGVSB Team | Sanitas Troesch | A | B | C |
|----------------------------|------------|-----------------|-----|----|---|
| PWA.1211.525 ^{a)} | 585 334 | 4721 963 | 155 | 80 | |
| PWA.1211.583 ^{b)} | 585 334 | 4721 963 | 155 | 80 | |

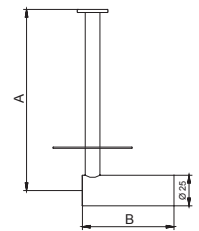

Ersatzrollenhalter

Porte-rouleau de réserve / Portacarta di riserva

Edelstahl, für 2 Rollen

Acier inoxydable, pour 2 rouleaux / Acciaio inossidabile, per 2 rotoli

| NOSAG | SGVSB Team | Sanitas Troesch | A | B | C |
|----------------------------|------------|-----------------|-----|----|---|
| PWA.1212.525 ^{a)} | 585 335 | 4721 964 | 280 | 80 | |
| PWA.1212.583 ^{b)} | 585 335 | 4721 964 | 280 | 80 | |

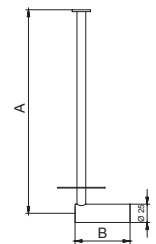

Bürstengarnitur

Ensemble brosse WC / Portaspazzola set

Edelstahl

Acier inoxydable / Acciaio inossidabile

| NOSAG | SGVSB Team | Sanitas Troesch | A | B | C |
|----------------------------|------------|-----------------|-----|-----|---|
| PWA.1312.525 ^{a)} | 585 336 | 4721 968 | 380 | 135 | |
| PWA.1312.583 ^{b)} | 585 336 | 4721 968 | 380 | 135 | |

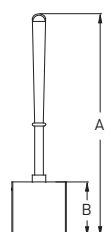

Haltegriffsystem Serie IneoLine Pure (Edelstahl)

Système de barres d'appui Série IneoLine Pure (acier inoxydable)

Sistema di maniglioni di sostegno Serie IneoLine Pure
(acciaio inossidabile)

WC-Bereich

Section toilette / Settore toilette



Pictogramme

Pictogramme / Pittogramma

Edelstahl, matt gebürstet, männliche Person

Acier inoxydable, mat, personnage masculin / Acciaio inossidabile, opaco, bagno uomini

| | | | | | |
|--------------|-------------------|------------------------|----------|----------|----------|
| NOSAG | SGVSB Team | Sanitas Troesch | A | B | C |
| NWA.1710.583 | | 4721 691 | 125 | 125 | |



Pictogramme

Pictogramme / Pittogramma

Edelstahl, matt gebürstet, weibliche Person

Acier inoxydable, mat, personnage féminin / Acciaio inossidabile, bagno donne

| | | | | | |
|--------------|-------------------|------------------------|----------|----------|----------|
| NOSAG | SGVSB Team | Sanitas Troesch | A | B | C |
| NWA.1711.583 | | 4721 692 | 125 | 125 | |



Pictogramme

Pictogramme / Pittogramma

Edelstahl, matt gebürstet, IV-WC

Acier inoxydable, mat, toilette pour handicapés / Acciaio inossidabile, opaco, bagno handicap

| | | | | | |
|--------------|-------------------|------------------------|----------|----------|----------|
| NOSAG | SGVSB Team | Sanitas Troesch | A | B | C |
| NWA.1712.583 | | 4721 693 | 125 | 125 | |

Haltegriffsystem Serie IneoLine Pure (Edelstahl)

Système de barres d'appui Série IneoLine Pure (acier inoxydable)

Sistema di maniglioni di sostegno Serie IneoLine Pure

(acciaio inossidabile)

WC-Bereich

Section toilette / Settore toilette



Hygiene-Abfallbehälter

Poubelle murale / Contenitore rifiuti per salviette igieniche

Edelstahl, Wandmontage, 4.5 Liter

Acier inoxydable, montage mural, 4.5 litre / Acciaio inossidabile, montaggio a parete, 4.5 litri

| NOSAG | SGVSB Team | Sanitas Troesch | CHF | A | B | C |
|----------------------------|------------|-----------------|-----|-----|-----|-----|
| MWA.1400.525 ^{a)} | 585 058 | | | 260 | 225 | 100 |
| MWA.1400.583 ^{b)} | 585 058 | | | 260 | 225 | 100 |

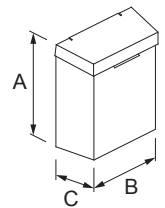

Hygienebeutelspender

Distributeur de sachets hygiéniques / Distributore di sacchetti igiene

Edelstahl

Acier inoxydable/ Acciaio inossidabile

| NOSAG | SGVSB Team | Sanitas Troesch | A | B | C |
|----------------------------|------------|-----------------|-----|----|----|
| MWA.1500.525 ^{a)} | 585 057 | | 170 | 95 | 24 |
| MWA.1500.583 ^{b)} | 585 057 | | 170 | 95 | 24 |

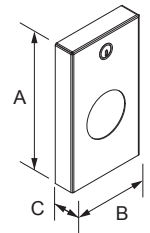

Abfallbehälter mit integriertem Hygienebeutelspender

Poubelle murale avec distributeur de sachets hygiéniques intégré /

Contenitore rifiuti con distributore sacchi igienici integrato

Edelstahl, Wandmontage, 4.5 Liter

Acier inoxydable, montage mural, 4.5 litre / Acciaio inossidabile, montaggio a parete, 4.5 litri

| NOSAG | SGVSB Team | Sanitas Troesch | A | B | C |
|----------------------------|------------|-----------------|-----|-----|-----|
| MWA.1510.525 ^{a)} | 585 056 | | 260 | 225 | 100 |
| MWA.1510.583 ^{b)} | 585 056 | | 260 | 225 | 100 |

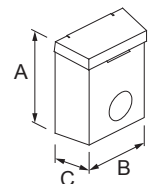

Haltegriffsystem Serie IneoLine Pure (Edelstahl)

Système de barres d'appui Série IneoLine Pure (acier inoxydable)

Sistema di maniglioni di sostegno Serie IneoLine Pure (acciaio inossidabile)

Dusch-Bereich

Section douche / Settore doccia



Brausestange

Glissières de douche / Asta per doccia

Edelstahl, mit DesignGrip by Nosag®, mit Brausehalter

Acier inoxydable, avec DesignGrip by Nosag®, avec support à rotule / Acciaio inossidabile, con DesignGrip by Nosag®, con supporto doccia

| NOSAG | SGVSB Team | Sanitas Troesch | A | B | C |
|----------------------------|------------|-----------------|------|---|---|
| PD0.0008.525 ^{a)} | 585 144 | 4721 935 | 800 | | |
| PD0.0009.525 ^{a)} | 585 145 | | 900 | | |
| PD0.0010.525 ^{a)} | 585 146 | 4721 937 | 1000 | | |
| PD0.0011.525 ^{a)} | 585 147 | 4721 938 | 1100 | | |
| PD0.0008.583 ^{b)} | 585 144 | 4721 935 | 800 | | |
| PD0.0009.583 ^{b)} | 585 145 | | 900 | | |
| PD0.0010.583 ^{b)} | 585 146 | 4721 937 | 1000 | | |
| PD0.0011.583 ^{b)} | 585 147 | 4721 938 | 1100 | | |

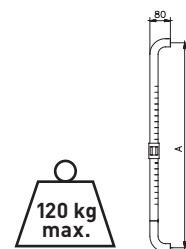

Winkelgriff mit Brausestange

Barre d'appui avec glissière de douche / Corrimano ad angolo con asta per doccia

Edelstahl, mit DesignGrip by Nosag®, mit Brausehalter

Acier inoxydable, avec DesignGrip by Nosag®, avec support à rotule / Acciaio inossidabile, con DesignGrip by Nosag®, con supporto doccia

| NOSAG | SGVSB Team | Sanitas Troesch | A | B | C |
|------------------------------|------------|-----------------|------|-----|---|
| PD1.0051.525.L ^{a)} | 585 162 | 4721 931 | 1200 | 500 | |
| PD1.0051.525.R ^{a)} | 585 163 | 4721 932 | 1200 | 500 | |
| PD1.0061.525.L ^{a)} | 585 164 | | 1200 | 600 | |
| PD1.0061.525.R ^{a)} | 585 165 | | 1200 | 600 | |
| PD1.0051.583.L ^{b)} | 585 162 | 4721 931 | 1200 | 500 | |
| PD1.0051.583.R ^{b)} | 585 163 | 4721 932 | 1200 | 500 | |
| PD1.0061.583.L ^{b)} | 585 164 | | 1200 | 600 | |
| PD1.0061.583.R ^{b)} | 585 165 | | 1200 | 600 | |

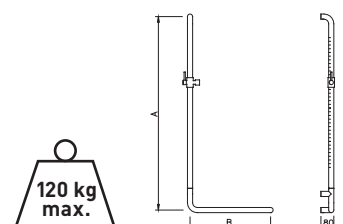

Haltegriffsystem Serie IneoLine Pure (Edelstahl)

Système de barres d'appui Série IneoLine Pure (acier inoxydable)

Sistema di maniglioni di sostegno Serie IneoLine Pure

(acciaio inossidabile)

Dusch-Bereich

Section douche / Settore doccia



Duschhandlauf T-Form

Barre d'appui en T avec glissière de douche / Corrimano a forma-T

Edelstahl, mit DesignGrip by Nosag®, mit Brausehalter, Brausestange verschiebbar

Acier inoxydable, avec DesignGrip by Nosag®, avec support à rotule, barre verticale coulissante latérale / Acciaio inossidabile, con DesignGrip by Nosag®, con supporto doccia, asta per doccia scorrevole

| NOSAG | SGVSB Team | Sanitas Troesch | A | B | C |
|-----------------------------|------------|-----------------|------|-----|---|
| PD1.0061.525. ^{a)} | | 4721 945 | 1200 | 600 | |
| PD1.0081.525. ^{a)} | 585 159 | 4721 946 | 1200 | 800 | |
| PD1.0061.583. ^{b)} | | 4721 945 | 1200 | 600 | |
| PD1.0081.583. ^{b)} | 585 159 | 4721 946 | 1200 | 800 | |

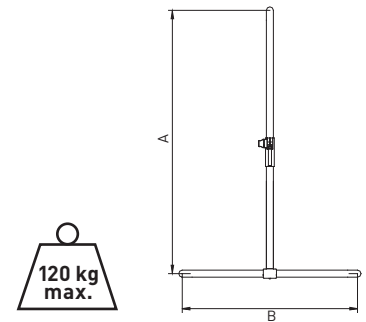

Duschhandlauf

Barre d'appui d'angle / Corrimano ad angolo

Edelstahl, mit DesignGrip by Nosag®

Acier inoxydable, avec DesignGrip by Nosag® / Acciaio inossidabile, con DesignGrip by Nosag®

| NOSAG | SGVSB Team | Sanitas Troesch | A | B | C |
|------------------------------|------------|-----------------|-----|-----|---|
| PD2.0002.525.L ^{a)} | 585 166 | 4721 941 | 763 | 763 | |
| PD2.0002.525.R ^{a)} | 585 160 | 4721 942 | 763 | 763 | |
| PD2.0002.583.L ^{b)} | 585 166 | 4721 941 | 763 | 763 | |
| PD2.0002.583.R ^{b)} | 585 160 | 4721 942 | 763 | 763 | |

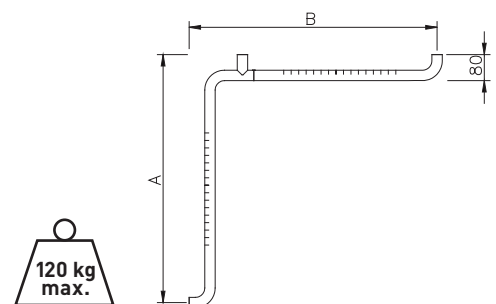

Haltegriffsystem Serie IneoLine Pure (Edelstahl)

Système de barres d'appui Série IneoLine Pure (acier inoxydable)

Sistema di maniglioni di sostegno Serie IneoLine Pure (acciaio inossidabile)

Dusch-Bereich

Section douche / Settore doccia



Duschhandlauf mit Brausehalterstange

Barre d'appui d'angle avec glissière de douche / Corrimano ad angolo con asta per doccia

Edelstahl, mit DesignGrip by Nosag® mit Brausehalter

Acier inoxydable, mat, avec DesignGrip by Nosag®, avec support à rotule / Acciaio inossidabile, opaco, con DesignGrip by Nosag®, con supporto doccia

| NOSAG | SGVSB Team | Sanitas Troesch | A | B | C |
|------------------------------|------------|-----------------|------|-----|-----|
| PD2.0102.525.L ^{a)} | 585 167 | 4721 933 | 1200 | 763 | 763 |
| PD2.0102.525.R ^{a)} | 585 168 | 4721 934 | 1200 | 763 | 763 |
| PD2.0102.583.L ^{b)} | 585 167 | 4721 933 | 1200 | 763 | 763 |
| PD2.0102.583.R ^{b)} | 585 168 | 4721 934 | 1200 | 763 | 763 |

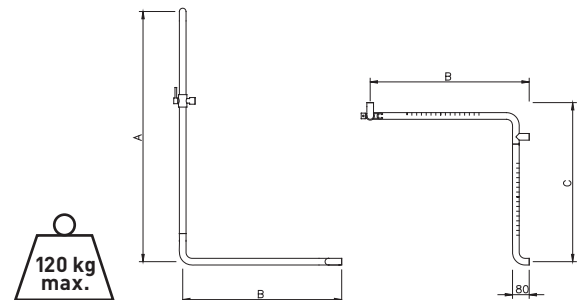

Duschhandlauf mit Brausehalterstange

Barre d'appui d'angle avec glissière de douche / Corrimano ad angolo con asta per doccia

Edelstahl, mit DesignGrip by Nosag®, mit Brausehalter, Brausestange verschiebbar

Acier inoxydable, avec DesignGrip by Nosag®, barre verticale coulissante latérale, avec support à rotule / Acciaio inossidabile, con DesignGrip by Nosag®, asta per doccia scorrevole, con supporto doccia

| NOSAG | SGVSB Team | Sanitas Troesch | A | B | C |
|------------------------------|------------|-----------------|------|-----|-----|
| PD2.0202.525.L ^{a)} | 585 169 | 4721 929 | 1200 | 763 | 763 |
| PD2.0202.525.R ^{a)} | 585 171 | 4721 930 | 1200 | 763 | 763 |
| PD2.0202.583.L ^{b)} | 585 169 | 4721 929 | 1200 | 763 | 763 |
| PD2.0202.583.R ^{b)} | 585 171 | 4721 930 | 1200 | 763 | 763 |

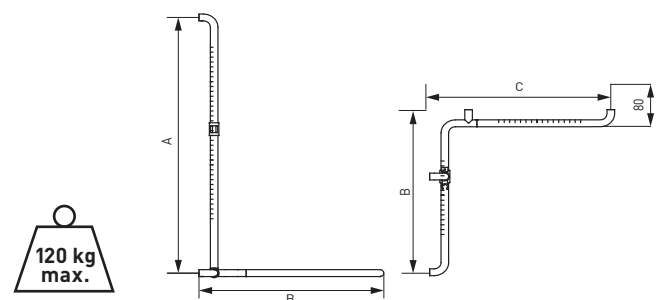

Haltegriffsystem Serie IneoLine Pure (Edelstahl)

Système de barres d'appui Série IneoLine Pure (acier inoxydable)

Sistema di maniglioni di sostegno Serie IneoLine Pure

(acciaio inossidabile)

Dusch-Bereich

Section douche / Settore doccia

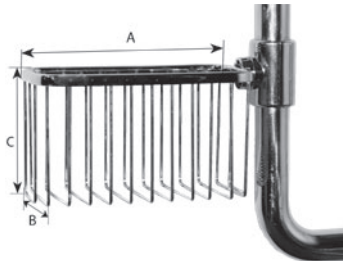

Duschablage

Tablette de douche / Portasapone doccia

Edelstahl, zum Anklemmen

Acier inoxydable, montage à la barre d'appui / Acciaio inossidabile, da incastro

| NOSAG | SGVSB Team | Sanitas Troesch | A | B | C |
|----------------------------|------------|-----------------|-----|-----|----|
| PDA.1125.525 ^{a)} | 585 170 | 4721 947 | 200 | 100 | 80 |
| PDA.1125.583 ^{b)} | 585 170 | 4721 947 | 200 | 100 | 80 |



Duschablage

Tablette de douche / Portasapone doccia

Nylon, dunkelgrau, zum Auflegen

Nylon, gris foncé, pour poser sur barre d'appui / Nylon, grigio scuro, da appoggiare

| NOSAG | SGVSB Team | Sanitas Troesch | A | B | C |
|--------------|------------|-----------------|----|-----|-----|
| NDA.4113.337 | 586 241 | 4721 151 | 75 | 210 | 110 |

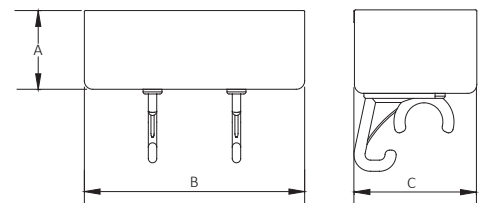

Brausehalter

Support à rotule / Supporto doccia

Edelstahl, d = 32 mm

Acier inoxydable, d = 32 mm / Acciaio inossidabile, d = 32 mm

| NOSAG | SGVSB Team | Sanitas Troesch | A | B | C |
|----------------------------|------------|-----------------|---|---|---|
| LDA.1101.525 ^{a)} | 585 119 | | | | |
| LDA.1101.583 ^{b)} | 585 119 | | | | |

Haltegriffsystem Serie IneoLine Pure (Edelstahl)

Système de barres d'appui Série IneoLine Pure (acier inoxydable)

Sistema di maniglioni di sostegno Serie IneoLine Pure (acciaio inossidabile)

Dusch-Bereich

Section douche / Settore doccia

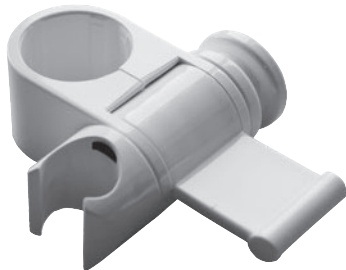

Brausehalter

Support à rotule / Supporto doccia

Nylon, d = 32 mm, dunkelgrau

Nylon, d = 32 mm, gris foncé / Nylon, d = 32 mm, grigio scuro

| NOSAG | SGVSB Team | Sanitas Troesch | A | B | C |
|--------------|------------|-----------------|---|---|---|
| NDA.4000.337 | 585 116 | | | | |

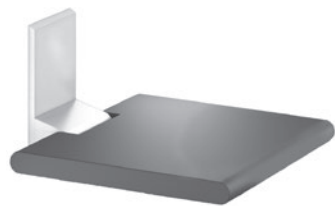

Duschklappsitz

Siège de douche rabattable / Sedile ribaltabile

Aluminium verchromt (501), für Wandmontage, mit Fallsicherung, **MIT Wechselplatte,**

Polster anthrazit Aluminium chromé (501), montage mural, avec frein de sécurité, **AVEC**

plaque interchangeable, rembourrage anthracite / Alluminio cromato (501), muro montaggio, con freno di sicurezza, **CON placca intercambiabile,** sedile imbottito, antracite

| NOSAG | SGVSB Team | Sanitas Troesch | A | B | C |
|--------------|------------|-----------------|-----|-----|---|
| ND3.6101.501 | 585 046 | | 380 | 462 | |
| ND3.6102.501 | 585 047 | | 450 | 462 | |

Aluminium anthrazit (900), silber (599) oder weiss (100), für Wandmontage, mit Fallsicherung, **MIT Wechselplatte,** Polster anthrazit

Aluminium anthracite (900), argent (599) ou blanc (100), montage mural, avec frein de sécurité, **AVEC plaque interchangeable,** rembourrage anthracite / Alluminio antracite (900), argento (599) o bianco (100), muro montaggio, con freno di sicurezza, **CON placca intercambiabile,** sedile imbottito, antracite

| NOSAG | SGVSB Team | Sanitas Troesch | A | B | C |
|-----------|------------|-----------------|-----|-----|---|
| ND3.6101. | 585 612 | 4721 751 | 380 | 462 | |
| ND3.6102. | 585 613 | 4721 752 | 450 | 462 | |

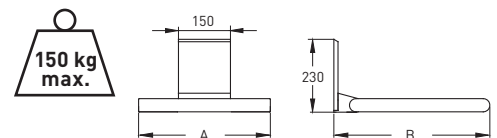

Montageset für

Set de montage pour / Set montaggio per

| | NOSAG | SGVSB Team | Sanitas Troesch | CHF |
|--|--------------|------------|-----------------|-----|
| Lochziegelsteine Brique / Mattone forato | NM1.0106.000 | 585 580 | 4721 795 | |
| Vorwandsysteme Murs préfabriqués / Muri prefabbricati | NM1.0206.000 | 585 581 | 4721 796 | |
| Beton Béton / Calcestruzzo | NM1.0306.000 | 585 599 | | |

Haltegriffsystem Serie IneoLine Pure (Edelstahl)

Système de barres d'appui Série IneoLine Pure (acier inoxydable)

Sistema di maniglioni di sostegno Serie IneoLine Pure

(acciaio inossidabile)

Dusch-Bereich

Section douche / Settore doccia

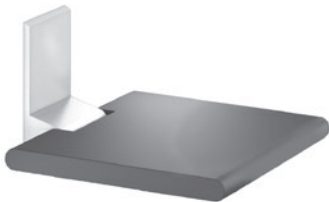

Duschklappsitz

Siège de douche rabattable / Sedile ribaltabile

Aluminium verchromt (501), für Wandmontage, mit Fallsicherung, **FÜR Wechselplatte**,
 Polster anthrazit Aluminium chromé (501), montage mural, avec frein de sécurité, **POUR**
plaque interchangeable, rembourrage anthracite / Alluminio cromato (501), muro montaggio,
 con freno di sicurezza, **PER placca intercambiabile**, sedile imbottito, antracite

| NOSAG | SGVSB Team | Sanitas Troesch | CHF | A | B | C |
|--------------|------------|-----------------|-----|-----|-----|---|
| ND3.6111.501 | 585 048 | | | 380 | 462 | |
| ND3.6112.501 | 585 049 | | | 450 | 462 | |

Aluminium anthrazit (900), silber (599) oder weiss (100), für Wandmontage, mit Fallsicherung,
FÜR Wechselplatte, Polster anthrazit

Aluminium antracite (900), argent (599) ou blanc (100), montage mural, avec frein de sécurité,
POUR plaque interchangeable, rembourrage anthracite / Alluminio antracite (900), argento
 (599) o bianco (100), muro montaggio, con freno di sicurezza, **PER placca intercambiabile**,
 sedile imbottito, antracite

| NOSAG | SGVSB Team | Sanitas Troesch | A | B | C |
|-----------|------------|-----------------|-----|-----|---|
| ND3.6111. | 585 614 | 4721 758 | 380 | 462 | |
| ND3.6112. | 585 615 | 4721 759 | 450 | 462 | |

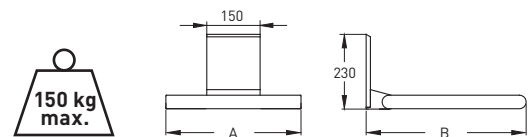

Haltegriffsystem Serie IneoLine Pure (Edelstahl)

Système de barres d'appui Série IneoLine Pure (acier inoxydable)

Sistema di maniglioni di sostegno Serie IneoLine Pure (acciaio inossidabile)

Dusch-Bereich

Section douche / Settore doccia

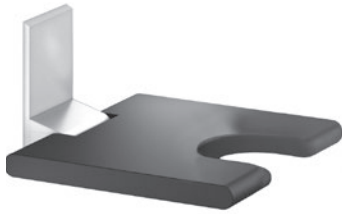

Duschklappsitz

Siège de douche rabattable / Sedile ribaltabile

Aluminium verchromt (501), mit Hygieneausschnitt, für Wandmontage, mit Fallsicherung, **MIT Wechselplatte**, Polster anthrazit

Aluminium chromé (501), avec échancrure, montage mural, avec frein de sécurité, **AVEC plaque interchangeable**, rembourrage anthracite / Alluminio cromato (501), con nicchia igiene, muro montaggio, con freno di sicurezza, **CON placca intercambiabile**, sedile imbottito, antracite

| NOSAG | SGVSB Team | Sanitas Troesch | A | B | C |
|----------------|------------|-----------------|-----|-----|---|
| ND3.6102.501.A | | | 450 | 462 | |

Aluminium anthrazit (900), silber (599) oder weiss (100), mit Hygieneausschnitt, für Wandmontage, mit Fallsicherung, **MIT Wechselplatte**, Polster anthrazit

Aluminium anthracite (900), argent (599) ou blanc (100), avec échancrure, montage mural, avec frein de sécurité, **AVEC plaque interchangeable**, rembourrage anthracite / Alluminio antracite (900), argento (599) o bianco (100), con nicchia igiene, muro montaggio, con freno di sicurezza, **CON placca intercambiabile**, sedile imbottito, antracite

| NOSAG | SGVSB Team | Sanitas Troesch | CHF | A | B | C |
|--------------|------------|-----------------|-----|-----|-----|---|
| ND3.6102.-.A | | | | 450 | 462 | |

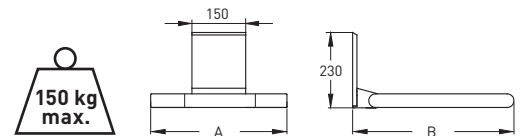

Montageset für

Set de montage pour / Set montaggio per

| | NOSAG | SGVSB Team | Sanitas Troesch |
|---|--------------|------------|-----------------|
| Lochziegelsteine Brique / Mattone forato | NM1.0106.000 | 585 580 | 4721 795 |
| Vorwandssysteme Murs préfabriqués / Muri prefabbricati | NM1.0206.000 | 585 581 | 4721 796 |
| Beton Béton / Calcestruzzo | NM1.0306.000 | 585 599 | |

Haltegriffsystem Serie IneoLine Pure (Edelstahl)

Système de barres d'appui Série IneoLine Pure (acier inoxydable)

Sistema di maniglioni di sostegno Serie IneoLine Pure

(acciaio inossidabile)

Dusch-Bereich

Section douche / Settore doccia

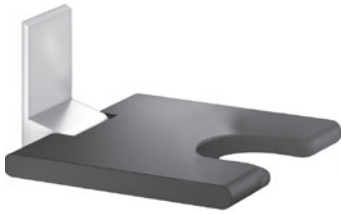

Duschklappsitz

Siège de douche rabattable / Sedile ribaltabile

Aluminium verchromt (501), mit Hygieneausschnitt, für Wandmontage, mit Fallsicherung, **FÜR Wechselplatte**, Polster anthrazit

Aluminium chromé (501), avec échancrure, montage mural, avec frein de sécurité, **POUR plaque interchangeable**, rembourrage anthracite / Alluminio cromato (501), con nicchia igiene, muro montaggio, con freno di sicurezza, **PER placca intercambiabile**, sedile imbottito, antracite

| NOSAG | SGVSB Team | Sanitas Troesch | A | B | C |
|----------------|------------|-----------------|-----|-----|---|
| ND3.6112.501.A | | | 450 | 462 | |

Aluminium anthrazit (900), silber (599) oder weiss (100), mit Hygieneausschnitt, für Wandmontage, mit Fallsicherung, **FÜR Wechselplatte**, Polster anthrazit

Aluminium anthracite (900), argent (599) ou blanc (100), avec échancrure, montage mural, avec frein de sécurité, **POUR plaque interchangeable**, rembourrage anthracite / Alluminio antracite (900), argento (599) o bianco (100), con nicchia igiene, muro montaggio, con freno di sicurezza, **PER placca intercambiabile**, sedile imbottito, antracite

| NOSAG | SGVSB Team | Sanitas Troesch | CHF | A | B | C |
|-------------|------------|-----------------|-----|-----|-----|---|
| ND3.6112.-A | | | | 450 | 462 | |

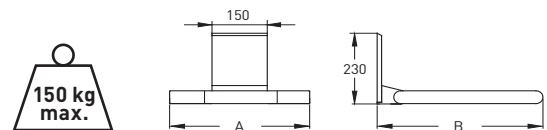

Montageplatte mit Abdeckung*

Plaque de base* / Placca di base con copertura*

Aluminium
Aluminium / Alluminio

| NOSAG | SGVSB Team | Sanitas Troesch | A | B | C |
|-----------|------------|-----------------|-----|-----|----|
| NWA.6013. | 585 589 | 4721 779 | 220 | 100 | 22 |

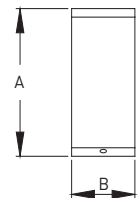

Montageset für

Set de montage pour / Set montaggio per

| | NOSAG | SGVSB Team | Sanitas Troesch |
|---|--------------|------------|-----------------|
| Lochziegelsteine Brique / Mattone forato | NM1.0106.000 | 585 580 | 4721 795 |
| Vorwandssysteme Murs préfabriqués / Muri prefabbricati | NM1.0206.000 | 585 581 | 4721 796 |
| Beton Béton / Calcestruzzo | NM1.0306.000 | 585 599 | |

a) = hochglanz poliert, poli, brillante / b) = matt gebürstet, mat, opaco

* Farbskala siehe Seite 254 / gamme de couleurs voir la page 254 / gamma di colori vedere pagina 254

Haltegriffsystem Serie IneoLine Pure (Edelstahl)

Système de barres d'appui Série IneoLine Pure (acier inoxydable)

Sistema di maniglioni di sostegno Serie IneoLine Pure (acciaio inossidabile)

Dusch-Bereich

Section douche / Settore doccia

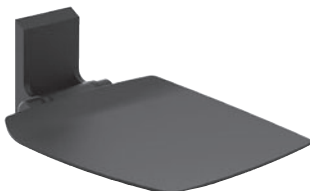

Duschklappsitz

Siège de douche rabattable / Sedile ribaltabile

Aluminium, mit Fallsicherung, für Wandmontage, Duschklappsitz komplett anthrazit

Aluminium, avec frein de sécurité, montage mural, siège de douche rabattable complètement anthracite / Alluminio, con freno di sicurezza, muro montaggio, sedile ribaltabile completamente antracite

| NOSAG | SGVSB Team | Sanitas Troesch | A | B | C |
|--------------|------------|-----------------|-----|-----|-----|
| ND3.6170.900 | 585 616 | 4721 785 | 412 | 419 | 512 |

Aluminium, mit Fallsicherung, für Wandmontage, Duschklappsitz komplett weiss

Aluminium, avec frein de sécurité, montage mural, siège de douche rabattable complètement blanc / Alluminio, con freno di sicurezza, muro montaggio, sedile ribaltabile completamente bianco

| NOSAG | SGVSB Team | Sanitas Troesch | A | B | C |
|--------------|------------|-----------------|-----|-----|-----|
| ND3.6170.100 | 585 616 | 4721 785 | 412 | 419 | 512 |

Montageset für

Set de montage pour / Set montaggio per

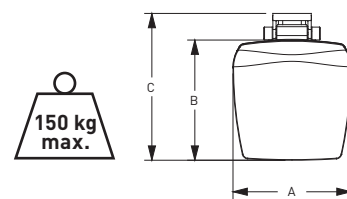

| | NOSAG | SGVSB Team | Sanitas Troesch |
|---|--------------|------------|-----------------|
| Lochziegelsteine Brique / Mattone forato | NM1.0106.000 | 585 580 | 4721 795 |
| Vorwandssysteme Murs préfabriqués / Muri prefabbricati | NM1.0206.000 | 585 581 | 4721 796 |
| Beton Béton / Calcestruzzo | NM1.0306.000 | 585 599 | 4721 798 |

Duschklappsitz*

Siège de douche rabattable* / Sedile ribaltabile*

Aluminium anthrazitgrau, mit Fallsicherung, zum Einhängen, mit Bodenstütze, Polster anthrazitgrau

Aluminium gris anthracite, avec frein de sécurité, à suspendre, avec pieds, rembourrage gris anthracite / Alluminio grigio antracite, con freno di sicurezza, per appendere, con pied d'appoggio, sedile imbottito, grigio antracite

| NOSAG | SGVSB Team | Sanitas Troesch | A | B | C |
|--------------|------------|-----------------|---|---|---|
| DD3.1510.391 | 585 045 | | | | |

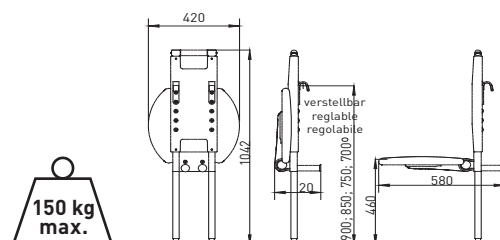

Haltegriffsystem Serie IneoLine Pure (Edelstahl)

Système de barres d'appui Série IneoLine Pure (acier inoxydable)

Sistema di maniglioni di sostegno Serie IneoLine Pure

(acciaio inossidabile)

Dusch-Bereich

Section douche / Settore doccia



Duschvorhangstangen gerade

Tringle droite pour rideau de douche / Doccia bastone per tende

Edelstahl, d = 22 mm, mit Vorhangringen, Nylon, weiss

Acier inoxydable, d = 22 mm, avec anneaux pour rideau, nylon, blanc / Acciaio inossidabile, d = 22 mm, tenda anelli, Nylon, bianco

| NOSAG | SGVSB Team | Sanitas Troesch | A | B | C |
|----------------------------|------------|-----------------|------|---|---|
| LD5.1008.525 ^{a)} | 171 541 | | 800 | | |
| LD5.1009.525 ^{a)} | 171 546 | | 900 | | |
| LD5.1010.525 ^{a)} | 171 547 | | 1000 | | |
| LD5.1011.525 ^{a)} | 171 548 | | 1100 | | |
| LD5.1008.583 ^{a)} | 171 541 | | 800 | | |
| LD5.1009.583 ^{a)} | 171 546 | | 900 | | |
| LD5.1010.583 ^{a)} | 171 547 | | 1000 | | |
| LD5.1011.583 ^{a)} | 171 548 | | 1100 | | |

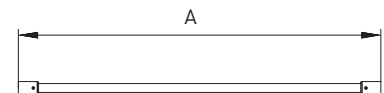

Duschvorhang

Rideau de douche / Tenda per doccia

100% Synthetik, waschbar 60°, weiss, antibakteriell

100% synthétique, lavable 60°, blanc, antibactérien / 100% sintetico, lavabile 60°, bianco, antibatterico

| NOSAG | SGVSB Team | Sanitas Troesch | A | B | C |
|--------------|------------|-----------------|------|------|---|
| LDA.5500.100 | | | 1200 | 2000 | |

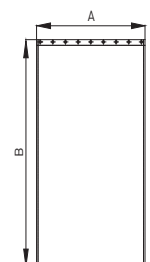

Haltegriffsystem Serie IneoLine Pure (Edelstahl)

Système de barres d'appui Série IneoLine Pure (acier inoxydable)

Sistema di maniglioni di sostegno Serie IneoLine Pure (acciaio inossidabile)

Dusch-Bereich

Section douche / Settore doccia



Duschvorhangstangen L-Form

Tringle pour rideau de douche form L / Doccia bastone per tende

Edelstahl, d = 22 mm, mit Vorhangringen, Nylon, weiss

Acier inoxydable, d = 22 mm, avec anneaux pour rideau, nylon, blanc / Acciaio inossidabile, d = 22 mm, tenda anelli, Nylon, bianco

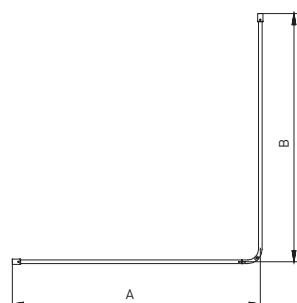

| NOSAG | SGVSB Team | Sanitas Troesch | A | B | C |
|----------------------------|------------|-----------------|------|------|---|
| LD5.1100.525 ^{al} | 171 549 | 4721 891 | 900 | 900 | |
| LD5.1101.525 ^{al} | 171 551 | 4721 892 | 1000 | 1000 | |
| LD5.1102.525 ^{al} | 171 550 | | 1100 | 1100 | |
| LD5.1103.525 ^{al} | 171 542 | 4721 894 | 1200 | 1200 | |
| LD5.1191.525 ^{al} | 171 543 | 4721 893 | 900 | 1100 | |
| LD5.1112.525 ^{al} | | | 1000 | 1200 | |
| LD5.1100.583 ^{bl} | 171 549 | 4721 891 | 900 | 900 | |
| LD5.1101.583 ^{bl} | 171 551 | 4721 892 | 1000 | 1000 | |
| LD5.1102.583 ^{bl} | 171 550 | | 1100 | 1100 | |
| LD5.1103.583 ^{bl} | 171 542 | 4721 894 | 1200 | 1200 | |
| LD5.1191.583 ^{bl} | 171 543 | 4721 893 | 900 | 1100 | |
| LD5.1112.583 ^{bl} | | | 1000 | 1200 | |



Duschvorhang

Rideau de douche / Tenda per doccia

100% Polyester, mit Bleiband, bei 60° waschbar, dauerhaft antibakteriell, weiss mit Struktur

Pour tringle forme L, polyester 100%, avec ourlet plombé, lavable à 60°, durablement antibactérien, blanc avec structure / Per aste doccia ad angolo, 100% poliestere, bordo incl. piombo, lavabile a 60°, antibatterico durevole, bianco con struttura

| NOSAG | SGVSB Team | Sanitas Troesch | A | B | C |
|--------------|------------|-----------------|------|------|---|
| NDA.5501.019 | 585 630 | | 2400 | 2000 | |
| NDA.5502.019 | 585 631 | | 3000 | 2000 | |

2400 x 2000 mm [16 Ösen / 16 oeillets / 16 occhielli], für Artikel Nr: LD5.1100. und LD5.1191. / pour l'article LD5.1100 et LD5.1191. / per articolo LD5.1100.e LD5.1191.

3000 x 2000 mm [20 Ösen / 20 oeillets / 20 occhielli], für Artikel Nr: LD5.1103. und LD5.1112. / pour l'article LD5.1103. et LD5.1112. / per articolo LD5.1103. e LD5.1112.

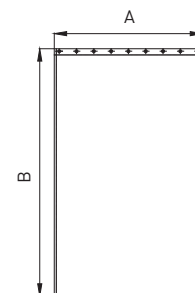

Haltegriffsystem Serie IneoLine Pure (Edelstahl)

Système de barres d'appui Série IneoLine Pure (acier inoxydable)

Sistema di maniglioni di sostegno Serie IneoLine Pure

(acciaio inossidabile)

Dusch-Bereich

Section douche / Settore doccia



Deckenabhängung

Fixation pour plafond / Supporto al plafone

Edelstahl, auf Mass kürzbar

Acier inoxydable possible de raccourcir soi même / Acciaio inossidabile accorciabile su misura

| NOSAG | SGVSB Team | Sanitas Troesch | A | B | C |
|----------------------------|------------|-----------------|------|---|---|
| LDA.1804.525 ^{al} | 171 544 | 4721 896 | 400 | | |
| LDA.1805.525 ^{al} | 171 556 | | 500 | | |
| LDA.1806.525 ^{al} | 171 545 | 4721 898 | 600 | | |
| LDA.1808.525 ^{al} | | | 800 | | |
| LDA.1810.525 ^{al} | 171 557 | | 1000 | | |
| LDA.1804.583 ^{bl} | 171 544 | 4721 896 | 400 | | |
| LDA.1805.583 ^{bl} | 171 556 | | 500 | | |
| LDA.1806.583 ^{bl} | 171 545 | 4721 898 | 600 | | |
| LDA.1808.525 ^{bl} | | | 800 | | |
| LDA.1810.583 ^{bl} | 171 557 | | 1000 | | |

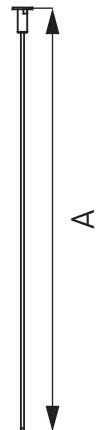

Duschspritzschutz

Pare éclaboussure / Protezione antischizzo

Edelstahl, mit Fallsicherung, für Wandmontage

Acier inoxydable, avec frein de sécurité, montage mural / Acciaio inossidabile, con freno di sicurezza, montaggio a parete

| NOSAG | SGVSB Team | Sanitas Troesch | A | B | C |
|----------------------------|------------|-----------------|-----|-----|-----|
| LD6.0008.525 ^{al} | | | 850 | 250 | 110 |
| LD6.0008.583 ^{bl} | | | 850 | 250 | 110 |

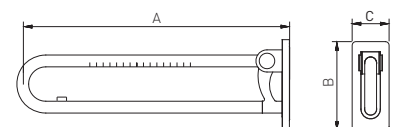

Haltegriffsystem Serie IneoLine Pure (Edelstahl)

Système de barres d'appui Série IneoLine Pure (acier inoxydable)

Sistema di maniglioni di sostegno Serie IneoLine Pure (acciaio inossidabile)

Dusch-Bereich

Section douche / Settore doccia



Duschspritzschutzvorhang

Rideau pour pare-éclaboussure / Tenda paraspruzzi

100% Polyesterstoff, Relief white, mit Bleiband, bei 40° waschbar

100% polyester étoffes, Relief white, avec ourlet, plombé, lavable à 40° / 100% poliester, Relief white, bordo incl. piombo, lavabile a 40°

NOSAG

LDA.0793.100

SGVSB Team

Sanitas Troesch

A

850

B

750

C

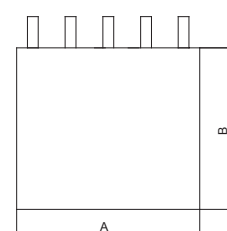

Duschspritzschutz mobil

Pare éclaboussure mobile / Protezione antischizzo mobile

Edelstahl

Acier inoxydable / Acciaio inossidabile

NOSAG

LD6.1500.525^{a)}

LD6.1500.583^{b)}

SGVSB Team

Sanitas Troesch

A

900

B

1000

C

900

1000

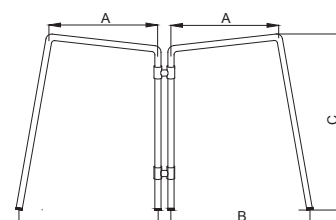

Haltegriffsystem Serie IneoLine Pure (Edelstahl)

Système de barres d'appui Série IneoLine Pure (acier inoxydable)

Sistema di maniglioni di sostegno Serie IneoLine Pure

(acciaio inossidabile)

Lavabo-Bereich

Section lavabo / Settore lavabo



Wandhaken

Crochet mural / Gancio a parete

Edelstahl, Ausladung 60 mm

Acier inoxydable, saillie 60 mm / Acciaio inossidabile, lunghezza 60 mm

| NOSAG | SGVSB Team | Sanitas Troesch | A | B | C |
|----------------------------|------------|-----------------|----|------|---|
| PLA.1711.525 ^{a)} | 585 337 | 4721 936 | 63 | 39.5 | |
| PLA.1711.583 ^{b)} | 585 337 | 4721 936 | 63 | 39.5 | |

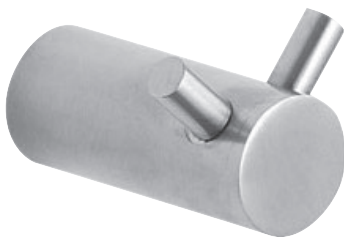
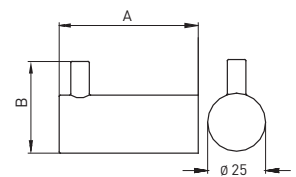

Wandhaken

Crochet mural / Gancio a parete

Edelstahl, Doppelhaken, Ausladung 60 mm

Acier inoxydable, crochet double, saillie 60 mm / Acciaio inossidabile, doppia gancio, lunghezza 60 mm

| NOSAG | SGVSB Team | Sanitas Troesch | A | B | C |
|----------------------------|------------|-----------------|----|---|---|
| PLA.1712.525 ^{a)} | 585 338 | 4721 939 | 63 | | |
| PLA.1712.583 ^{b)} | 585 338 | 4721 939 | 63 | | |

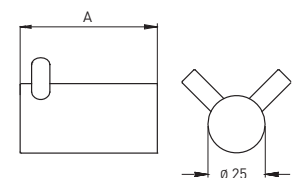

Haltegriff mit Handtuchhalter

Barre d'appui avec porte-serviette / Corrimano con portasalviette

Edelstahl, DesignGrip by Nosag®, 600 mm / 800 mm, max. Belastung 120 kg

Acier inoxydable, DesignGrip by Nosag®, 600 mm / 800 mm, charge max. 120 kg / Acciaio inossidabile, DesignGrip by Nosag®, 600 mm / 800 mm, carico ammissibile 120 kg

| NOSAG | SGVSB Team | Sanitas Troesch | A | B | C |
|----------------------------|------------|-----------------|-----|----|---|
| PLA.0630.525 ^{a)} | 585 339 | 4721 910 | 600 | 45 | |
| PLA.0631.525 ^{a)} | 585 340 | 4721 912 | 800 | 45 | |
| PLA.0630.583 ^{b)} | 585 339 | 4721 910 | 600 | 45 | |
| PLA.0631.583 ^{b)} | 585 340 | 4721 912 | 800 | 45 | |

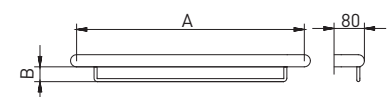

Haltegriffsystem Serie IneoLine Pure (Edelstahl)

Système de barres d'appui Série IneoLine Pure (acier inoxydable)

Sistema di maniglioni di sostegno Serie IneoLine Pure (acciaio inossidabile)

Lavabo-Bereich

Section lavabo / Settore lavabo



Handtuchhalter

Porte-serviette / Portasalviette

Edelstahl

Acier inoxydable / Acciaio inossidabile

| NOSAG | SGVSB Team | Sanitas Troesch | A | B | C |
|----------------------------|------------|-----------------|-----|---|---|
| PLA.1616.525 ^{a)} | 585 341 | | 600 | | |
| PLA.1616.583 ^{b)} | 585 341 | | 600 | | |



Glashalter

Porte-verre / Portabicchiere

Edelstahl, mit Glas

Acier inoxydable, avec verre / Acciaio inossidabile, con bicchiere

| NOSAG | SGVSB Team | Sanitas Troesch | A | B | C |
|----------------------------|------------|-----------------|----|-----|-----|
| PLA.1111.525 ^{a)} | 585 342 | 4721 951 | 95 | 103 | 103 |
| PLA.1111.583 ^{b)} | 585 342 | 4721 951 | 95 | 103 | 103 |

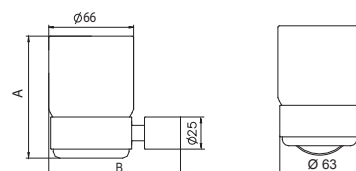

Doppelglashalter

Porte-verre / Portabicchiere doppio

Edelstahl, mit Glas

Acier inoxydable, avec verre / Acciaio inossidabile, con bicchiere

| NOSAG | SGVSB Team | Sanitas Troesch | A | B | C |
|----------------------------|------------|-----------------|----|-----|----|
| PLA.1112.525 ^{a)} | 585 343 | | 95 | 176 | 83 |
| PLA.1112.583 ^{b)} | 585 343 | | 95 | 176 | 83 |

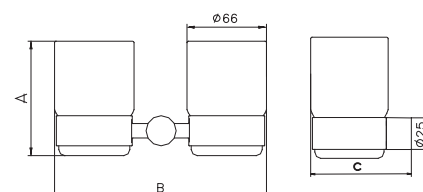

Haltegriffsystem Serie IneoLine Pure (Edelstahl)

Système de barres d'appui Série IneoLine Pure (acier inoxydable)

Sistema di maniglioni di sostegno Serie IneoLine Pure

(acciaio inossidabile)

Lavabo-Bereich

Section lavabo / Settore lavabo



Seifenablage

Porte-savon / Portasapone

| NOSAG | SGVSB Team | Sanitas Troesch | A | B | C |
|----------------------------|------------|-----------------|----|-----|---|
| PLA.1311.525 ^{a)} | 585 344 | 4721 943 | 45 | 126 | |
| PLA.1311.583 ^{b)} | 585 344 | 4721 943 | 45 | 126 | |

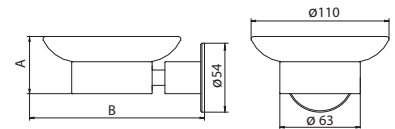

Wandseifenspender BALI LUX

Distributeur de savon mural BALI LUX / Distributore di sapone BALI LUX

Edelstahl, Wandmontage, für 700 ml Schaumseife BALI PLUS /

Desinfizierende Schaumseife BALI DISINFECTING

Acier inoxydable, montage mural, pour 700 ml savon en mousse BALI PLUS /

Savon en mousse désinfectant BALI DISINFECTING /

Acciaio inossidabile, montaggio a parete, per 700 ml sapone schiuma BALI PLUS /

Sapone schiuma disinfettante BALI DISINFECTING

| NOSAG | SGVSB Team | Sanitas Troesch | A | B | C |
|----------------------------|------------|-----------------|-----|-----|-----|
| MLA.1307.525 ^{a)} | 585 050 | | 260 | 104 | 102 |
| MLA.1307.583 ^{b)} | 585 050 | | 260 | 104 | 102 |

Schaumseife BALI PLUS

Savon en mousse BALI PLUS / Sapone schiuma BALI PLUS

| NOSAG | SGVSB Team | Sanitas Troesch | A | B | C |
|--------------|------------|-----------------|---|---|---|
| MLE.M12P.000 | | | | | |

Desinfizierende Schaumseife BALI DISINFECTING

Savon en mousse désinfectant BALI DISINFECTING / Sapone schiuma disinfettante

BALI DISINFECTING

| NOSAG | SGVSB Team | Sanitas Troesch | A | B | C |
|--------------|------------|-----------------|---|---|---|
| MLE.M14P.000 | | | | | |

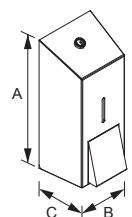

Haltegriffsystem Serie IneoLine Pure (Edelstahl)

Système de barres d'appui Série IneoLine Pure (acier inoxydable)

Sistema di maniglioni di sostegno Serie IneoLine Pure
(acciaio inossidabile)

Lavabo-Bereich

Section lavabo / Settore lavabo



Wandseifenspender MAXI

Distributeur de savon mural MAXI / Distributore di sapone MAXI

Edelstahl, Wandmontage, für 880 ml handelsübliche Flüssigseife oder Desinfektionsmittel

Acier inoxydable, montage mural, convient pour 800 ml de savon liquide commercial ou de désinfectant / Acciaio inossidabile, montaggio a parete, per 800 ml sapone liquido e disinfettante d'uso commerciale

| NOSAG | SGVSB Team | Sanitas Troesch | A | B | C |
|----------------------------|------------|-----------------|-----|-----|-----|
| MLA.1318.525 ^{a)} | 585 051 | | 260 | 120 | 110 |
| MLA.1318.583 ^{b)} | 585 051 | | 260 | 120 | 110 |

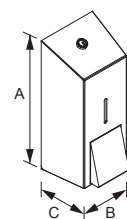

Papierhandtuchspender MINI

Distributer de serviettes en papier MINI / Distributore d'asciugamani MINI

Edelstahl, Wandmontage, für 250 Blätter, für C/Z-Falz

Acier inoxydable, montage mural, pour 250 serviettes, pour plié C/Z / Acciaio inossidabile, montaggio a parete, per 250 foglie, per piegatura a C/Z

| NOSAG | SGVSB Team | Sanitas Troesch | A | B | C |
|----------------------------|------------|-----------------|-----|-----|-----|
| MLA.1202.525 ^{a)} | 585 052 | | 155 | 255 | 120 |
| MLA.1202.583 ^{b)} | 585 052 | | 155 | 255 | 120 |

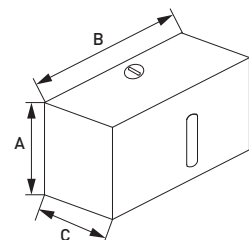

Haltegriffsystem Serie IneoLine Pure (Edelstahl)

Système de barres d'appui Série IneoLine Pure (acier inoxydable)

Sistema di maniglioni di sostegno Serie IneoLine Pure

(acciaio inossidabile)

Lavabo-Bereich

Section lavabo / Settore lavabo



Papierhandtuchspender MAXI

Distributer de serviettes en papier MAXI / Distributore d'asciugamani MAXI

Edelstahl, Wandmontage, für 500 Blätter, für C/Z-Falz

Acier inoxydable, montage mural, pour 500 serviettes, pour plié C/Z / Acciaio inossidabile, montaggio a parete, per 500 foglie, per piegatura a C/Z

| NOSAG | SGVSB Team | Sanitas Troesch | A | B | C |
|----------------------------|------------|-----------------|-----|-----|-----|
| MLA.1205.525 ^{a)} | 585 053 | | 265 | 255 | 120 |
| MLA.1205.583 ^{b)} | 585 053 | | 265 | 255 | 120 |

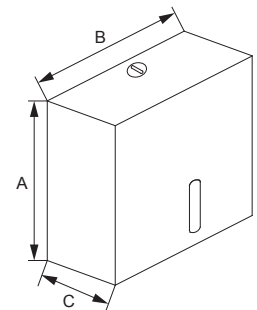

Abfallbehälter

Poubelle murale / Contenitore rifiuti

Edelstahl, Wandmontage, 27 Liter

Acier inoxydable, montage mural, 27 litre / Acciaio inossidabile, montaggio a parete, 27 litri

| NOSAG | SGVSB Team | Sanitas Troesch | A | B | C |
|----------------------------|------------|-----------------|-----|-----|-----|
| MLA.1402.525 ^{a)} | 585 054 | | 595 | 340 | 165 |
| MLA.1402.583 ^{b)} | 585 054 | | 595 | 340 | 165 |

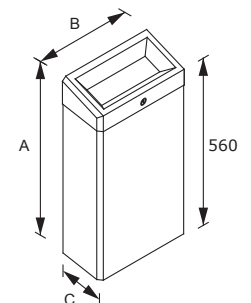

Haltegriffsystem Serie IneoLine Pure (Edelstahl)

Système de barres d'appui Série IneoLine Pure (acier inoxydable)

Sistema di maniglioni di sostegno Serie IneoLine Pure
(acciaio inossidabile)

Lavabo-Bereich

Section lavabo / Settore lavabo



Abfallbehälter

Poubelle murale / Contenitore rifiuti

Edelstahl, Wandmontage, 47 Liter

Acier inoxydable, montage mural, 47 litre / Acciaio inossidabile, montaggio a parete, 47 litri

| NOSAG | SGVSB Team | Sanitas Troesch | A | B | C |
|----------------------------|------------|-----------------|-----|-----|-----|
| MLA.1404.525 ^{a)} | 585 055 | | 626 | 330 | 244 |
| MLA.1404.583 ^{b)} | 585 055 | | 626 | 330 | 244 |

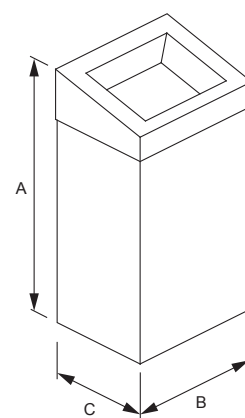

Haltegriffsystem Serie IneoLine Pure (Edelstahl)

Système de barres d'appui Série IneoLine Pure (acier inoxydable)

Sistema di maniglioni di sostegno Serie IneoLine Pure

(acciaio inossidabile)

Lavabo-Bereich

Section lavabo / Settore lavabo

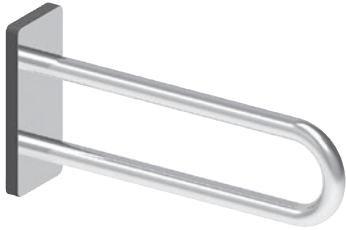

Stützgriff

Barre d'appui / Impugnatura di supporto

Edelstahl, mit DesignGrip by Nosag®

Acier inoxydable, avec DesignGrip by Nosag® / Acciaio inossidabile, con DesignGrip by Nosag®

| NOSAG | SGVSB Team | Sanitas Troesch | A | B | C |
|----------------------------|------------|-----------------|-----|-----|-----|
| LL0.0006.525 ^{a)} | | | 600 | 250 | 110 |
| LL0.0006.583 ^{b)} | | | 600 | 250 | 110 |

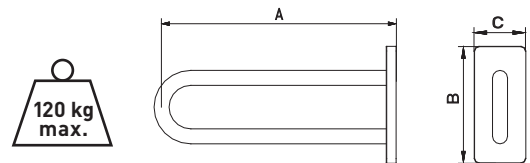

Montageset für

Set de montage pour / Set montaggio per

| | NOSAG | SGVSB Team | Sanitas Troesch |
|---|--------------|------------|-----------------|
| Lochziegelsteine Brique / Mattone forato | LM1.0100.000 | 585 390 | 4721 387 |
| Vorwandssysteme Murs préfabriqués / Muri prefabbricati | LM1.0200.000 | 585 391 | 4721 388 |
| Beton Béton / Calcestruzzo | LM1.0300.000 | 585 392 | |
| Vollgipsplatten Plaque alba / Lastre gesso | LM1.0500.000 | 585 394 | |

Haltegriffsystem Serie IneoLine Pure (Edelstahl)

Système de barres d'appui Série IneoLine Pure (acier inoxydable)

Sistema di maniglioni di sostegno Serie IneoLine Pure (acciaio inossidabile)

Wickeltische

Section Tables à langer / Fasciatoio



Wickeltisch Kiddy

Table à langer Kiddy / Fasciatoio Kiddy

Stahl, weiss beschichtet, für Wandmontage, inkl. Matratze, inkl. Montagematerial

Tube d'acier thermolaqué, blanc montage mural, matelas incl., set de montage incl. /

Acciaio verniciatura bianca, per muro fissaggio, incl. materasso, con materiale di fissaggio

NOSAG

GL7.7000.100

SGVSB Team

585 431

Sanitas Troesch

4772 140

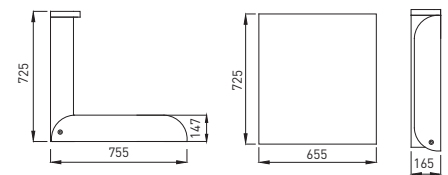

Wickeltisch NATHI

Table à langer NATHI / Fasciatoio NATHI

Birke lackiert, für Wandmontage, inkl. Matratze, inkl. Montagematerial

Bouleau laqué, montage mural, matelas incl., set de montage incl. / Betulla laccato, per muro fissaggio, incl. materasso, con materiale di fissaggio

NOSAG

DL7.9000.731

SGVSB Team

585 432

Sanitas Troesch

4772 141

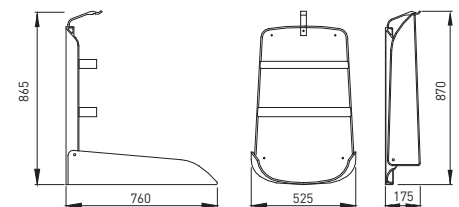

Wickeltisch Teddy

Table à langer Teddy / Fasciatoio Teddy

Polyamid, manhattan, für Wandmontage, mit eingebautem Handtuchspender, inkl. Montagematerial

polyamide, manhattan, montage mural, avec distributeur de serviettes intégré, incl. set de montage /

poliammide, manhattan, montaggio murale, con distributore asciugamani integrato, materasso incl.

materiale di fissaggio incl.

NOSAG

ML7.5000.133

SGVSB Team

Sanitas Troesch

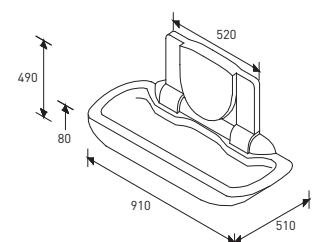

Haltegriffsystem Serie IneoLine Pure (Edelstahl)

Système de barres d'appui Série IneoLine Pure (acier inoxydable)

Sistema di maniglioni di sostegno Serie IneoLine Pure (acciaio inossidabile)

Badewannen-Bereich

Section baignoire / Settore vasca da bagno



Winkelgriff

Poignée latérale / Corrimano ad angolo

Edelstahl, mit DesignGrip by Nosag®, 135°

Acier inoxydable, avec DesignGrip by Nosag®, 135° / Acciaio inossidabile, con DesignGrip by Nosag®, 135°

| NOSAG | SGVSB Team | Sanitas Troesch | A | B | C |
|------------------------------|------------|-----------------|-----|-----|---|
| PB1.0035.525.L ^{a)} | | | 300 | 500 | |
| PB1.0035.525.R ^{a)} | | | 300 | 500 | |
| PB1.0035.583.L ^{b)} | | | 300 | 500 | |
| PB1.0035.583.R ^{b)} | | | 300 | 500 | |

